

# Fe<sup>26</sup> | IRON RAILING SIMPLIFIED



CODE  
COMPLIANCE



Intertek  
CCRR-0192



[www.FortressRailing.com](http://www.FortressRailing.com)

## IRON MADE. FORTRESS STRONG.

Fortress Fe<sup>26</sup> Iron Railing is a pre-welded, easily customized and enhanced version of traditional wrought iron railing that brings unparalleled quality to any patio, deck, balcony or porch. It provides a clean, classic appearance that is versatile for a variety of applications and surfaces. Pre-galvanized steel, zinc phosphate, e-coat and premium powder coating make it the most elegant and durable iron railing system on the market.







## FEATURES & BENEFITS

- Pre-welded Panels with Patented bracket system
- FortressShield Coated utilizing advanced automotive coating process to resist rust and corrosion
- Many customizing options to choose from
- Use with Wood, Composite, Vinyl or Fortress Iron Posts
- Quick and Easy Installation
- Fortress Fe<sup>26</sup> Panels are tested in accordance with AC273 & OBC/NBCC

## SIMPLE ASSEMBLY EASY AS 1, 2, 3 **FORTRESS**

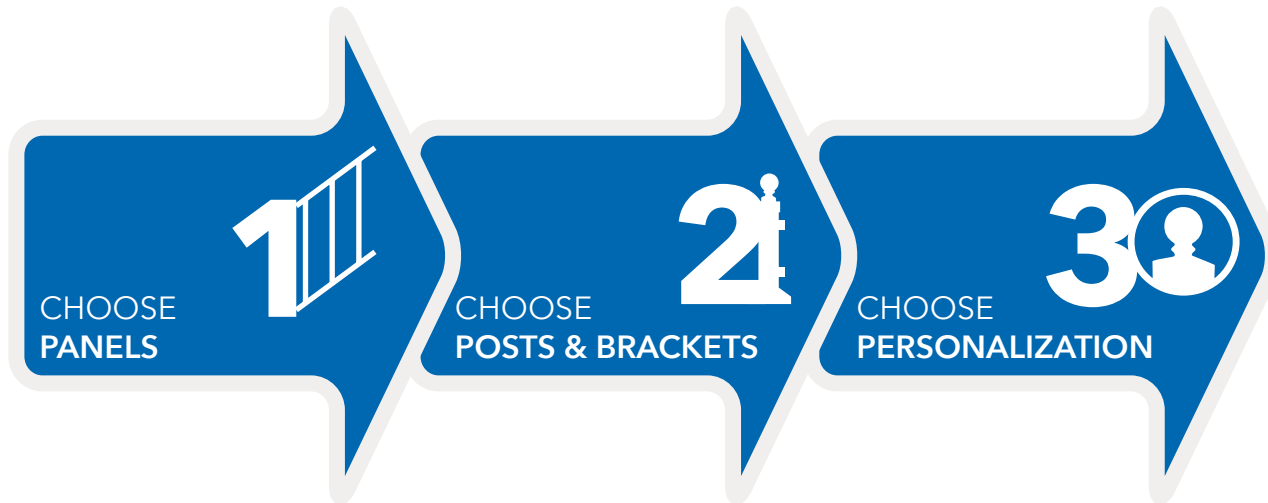

# FORTRESS

## PREMIUM FINISH

Fortress Fe<sup>26</sup> Iron Railing is available in three premium finishes engineered to withstand the elements.



Protected with



Premium Powder Coat  
E-Coat  
Quality Pre-treatment  
Zinc Galvanized

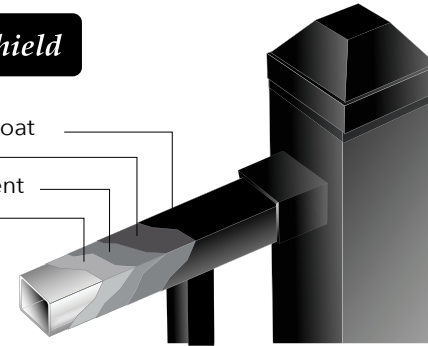

# Fe<sup>26</sup> | IRON RAILING

## SELECTION SIMPLIFIED

### | PANELS

All panels can be used with several types of posts such as Metal, Wood, Vinyl or Composite

#### LEVEL

##### TRADITIONAL

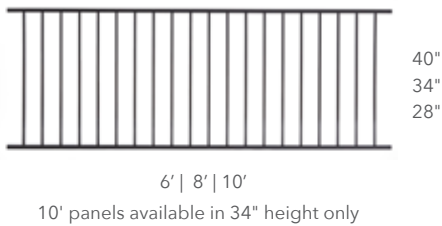

##### ORNAMENTAL

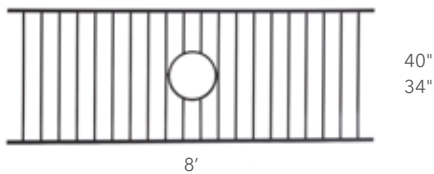

##### VIENNA

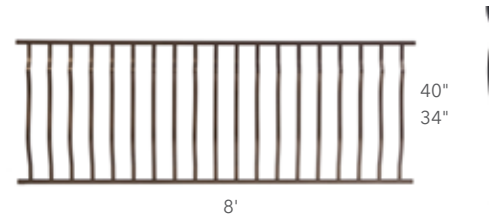

#### STAIR

##### TRADITIONAL ADJUSTABLE

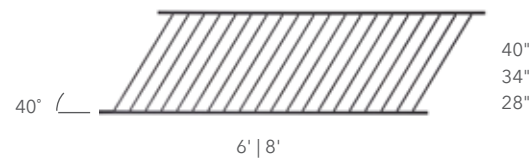

I-Support  
(Panel support optional)

Reference the Fortress Railing Product Grid on page 65 for exact dimensions





## 2 | POSTS & BRACKETS

### POSTS

All post base plates are pre-drilled enabling ease of wiring for lighting installations

45.5" | 55"  
(Goes with 38" Railing panel or 34" Rail panel when using Accent Top Panels)

39.5" | 49"  
(Goes with 34" Railing panel and with 28" Rail panel when using Accent Top Panel)

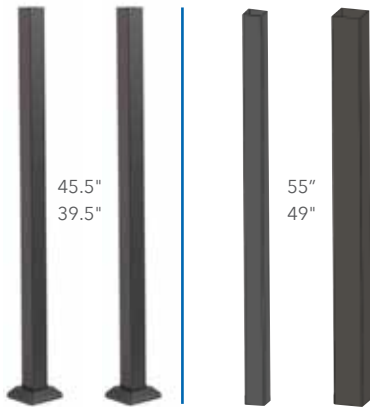

(Post Base Cover included in Post Box with 39.5" and 45.5" Posts")

2" 3" 2" 3"  
(For Fascia Mount applications only)

Base Cover not Required

### BRACKETS

#### UNIVERSAL BRACKET Hidden Fasteners (Patented)



UB  
(Level)

UB-ANG  
(Add to Universal Bracket for Stair or Angle/Miter Application)

#### PATIO BRACKET



Patio Bracket Standard  
(Level)

Patio Bracket ADJ  
(Stair or Angle/Miter Applications)

(For on-grade 30" or less above ground)

#### COLLAR BRACKET Traditional Fasteners



CB  
(Level)

CBS-ADJ  
(Angle/Miter)

CB-ADJ  
(Stair)

#### FASCIA MOUNT BRACKET



STRAIGHT  
BRACKET

INSIDE CORNER  
BRACKET

OUTSIDE CORNER  
BRACKET

## PANEL ACCESSORIES

### ACCENT TOP PANEL

Basket (Gloss Black Only)

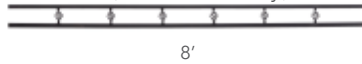

Ring Top



Circle Top

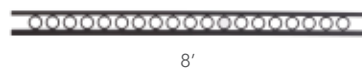

3 Rail

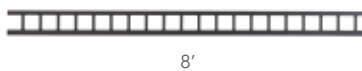

### ACCENT TOP RAIL

Colonial Round



### KNUCKLES



### CAP RAIL CLIP



### ORNAMENTS



2D Star



3D Star



4CS



Mountains



Elk

(To be used for ornamental panels only)

## GATES

### TRADITIONAL GATE



34.5"

40"  
34"

(Hinges, Locks and Latches are available)

### GATE UPRIGHTS

(Make a gate)

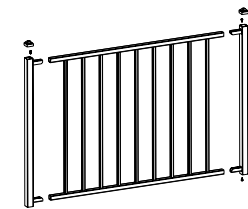

40"  
34"

Maximum Overall width 48"



## POST ACCESSORIES

### CAPS

(Without Lighting Capability)



Pressed Dome Cap  
2" | 3"

Ball Cap  
2" | 3"  
(Gloss Black only)

### CAPS

(With Lighting Capability)



Flat Pyramid Cap  
(For details on applications visit the  
FortressAccents on Page 45)

2" | 3"  
Shown with Cap  
Light Kit

2" | 3"  
Shown with  
Glow Ring

### POST BASE COVER

(Use with Wood, Vinyl or  
Composite Posts)



3.5" | 4" | 5" | 6"  
This is available in ALL finishes of  
Gloss Black, Antique Bronze, White,  
& Black Sand

## ACCENT LIGHTING LED LIGHT MOUNTS

(For details on applications visit the  
FortressAccents on Page 45)



## HANDRAIL SQUARE (IRON)

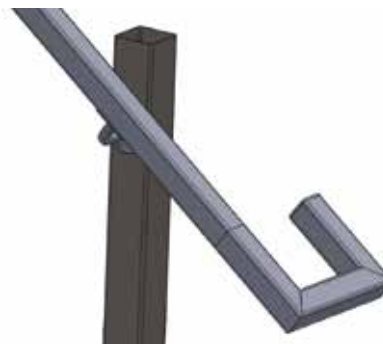

## ROUND (ALUMINUM)

